

Article number: 03468017

Description: Fluro Rod end EI 17D-NIRO

Note: 17

Measures

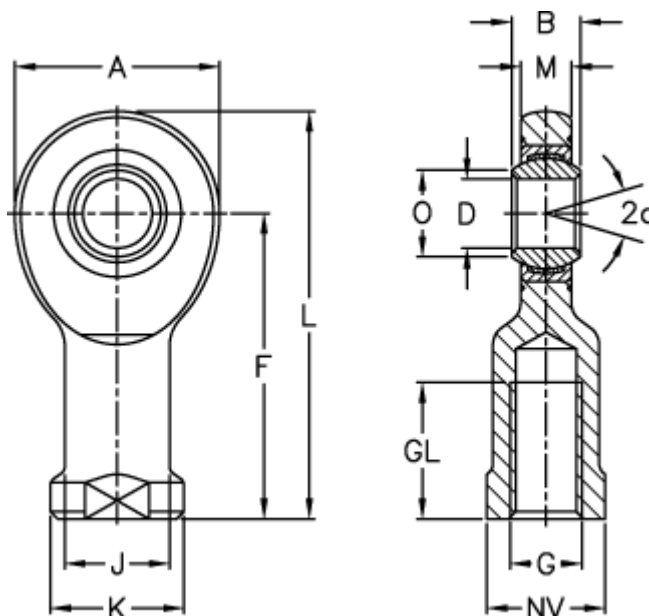

A	= 46	J	= 24
a (degrees)	= 10	K	= 30
B	= 14	L	= 90
D	= 17	M	= 11
Dynamic drive (kN)	= 39	NV	= 27
F	= 67	O	= 20.7
g	= M16	Static drive kN	= 34
GL	= 33	Weight	= 220